

Future Possibilities for HERA

G. H. Hoffstaetter, DESY, Hamburg, Germany*

Abstract

During a shut down period of 9 months starting September 2000 two interaction regions of HERA will be upgraded. The interacting sizes of the electron and the proton beams will be reduced by moving superconducting quadrupoles into the detectors of H1 and ZEUS. To match the proton beam, the size of the electron beam will be further reduced by decreasing the horizontal electron emittance. These measures should increase the maximum luminosity from the current $2 \cdot 10^{31} \text{cm}^{-2} \text{s}^{-1}$ to $4.7 \cdot 10^{31} \text{cm}^{-2} \text{s}^{-1}$. If in addition the design currents are reached, a luminosity of $7.6 \cdot 10^{31} \text{cm}^{-2} \text{s}^{-1}$ is expected. Spin rotators will be installed around the two collider experiments to deliver a longitudinally polarized electron beam. The technical components and concepts for handling the synchrotron radiation background in the detector region will be critical and the changes in the dynamics of the polarized electron beam have been analyzed.

For the time after the program for collisions of protons with polarized electrons has come to an end several years after this luminosity upgrade, the high energy community has expressed strong interest in new physics at HERA. Three possible future concepts will be described. A) Storing light and heavy ions for collisions with polarized electrons in HERA. B) Accelerating and storing polarized protons for polarized e/p collisions in HERA. C) Accelerating and storing polarized deuterons in HERA for a simultaneous analysis of polarized e/p and polarized e/n collisions. Some of these concepts will only be feasible after installing an electron cooler in PETRA and/or HERA. The electron beam for these collisions could come from HERA or possibly from TESLA.

1 STATUS OF HERA

With a length of 6336m, HERA is the largest accelerator at DESY in Hamburg. It provides collisions between a 920GeV proton beam and a 27.5GeV polarized electron beam and supplies four high energy physics experiments. H1 and ZEUS are the world's only high energy e/p collider experiments; HERMES and HERA-B have a fixed target. HERA-B scrapes the proton halo with wires to investigate parity violation in the B-system and HERMES has a polarized gas storage cell target in the polarized electron beam to analyze the polarized quark-gluon-structure of the nucleons. HERMES is currently the only experiment which takes advantage of the typically 60% polarization of the electron beam, since only around this experiment spin rotators bring the polarization in a longitudinal direction.

Altogether there are 10 accelerators at DESY, 8 of which are required for providing HERA's high energy collisions. The other two are the 2nd generation light source DORIS and the TESLA Test Facility (TTF) with its integrated SASE FEL which produces the world's highest energy FEL x-ray beams with wavelengths between 180nm and 80nm. This facility will be upgraded to 6nm wavelength by 2003 and is a test bed for the 33km long TESLA linear collider.

Several parameters contribute to the integrated luminosity of a collider. Figure 1 shows some of these parameters for HERA as they developed during the last 2 years. One important parameter is the run efficiency (top). It is defined as the luminosity time over the totally scheduled time so that it will never be greater than about 80%. The run efficiency had an average increase to in between 50 and 60% and the integrated luminosity can therefore no longer be largely increased by increasing the run efficiency.

Another important parameters is the beam current (middle). Over the years the electron current (green, lower curve) has increased to 50mA, close to its design value at 56mA. Also the proton current (red, upper curve) has increased and currently saturates at about 100mA. These currents and slight optical modifications have lead to an increase in the luminosity. The design value of $1.5 \cdot 10^{31} \text{cm}^{-2} \text{s}^{-1}$ has now been reached and surpassed (bottom).

Figure 2 shows how the integrated luminosity increased over the years in an exponential way to a total of around 180pb^{-1} . But by now a regime has been reached for which the curve is linear with time. To obtain a faster collection of integrated luminosity, a luminosity upgrade project is required. But this is not only a natural accelerator development, it is also strongly requested by the high energy physics community especially for the closer investigation of an unexpected excess of events over standard model predictions for high x and high Q^2 .

2 THE LUMINOSITY UPGRADE

For equal proton emittances $\epsilon_{px} = \epsilon_{py}$ and assuming that the proton beam size at the interaction point (IP) can always be matched by the electron beam ($\sigma_p = \sigma_e$), equation 1 shows that the luminosity can be increased by boosting the brightness $N_{ppb}^p / \epsilon_{px}$ of the p beam, by increasing the e current I_e , or by a decrease of the p beta functions at the collision point. These three measures have been found to be about equally expensive but modifying the interaction region for obtaining smaller beta functions was found to be the safest method.

$$\mathcal{L} = \frac{N_{ppb}^p}{\epsilon_{px}} \frac{I_e}{4\pi e} \frac{1}{\sqrt{\beta_{px}\beta_{py}}} \quad (1)$$

* Georg.Hoffstaetter@desy.de

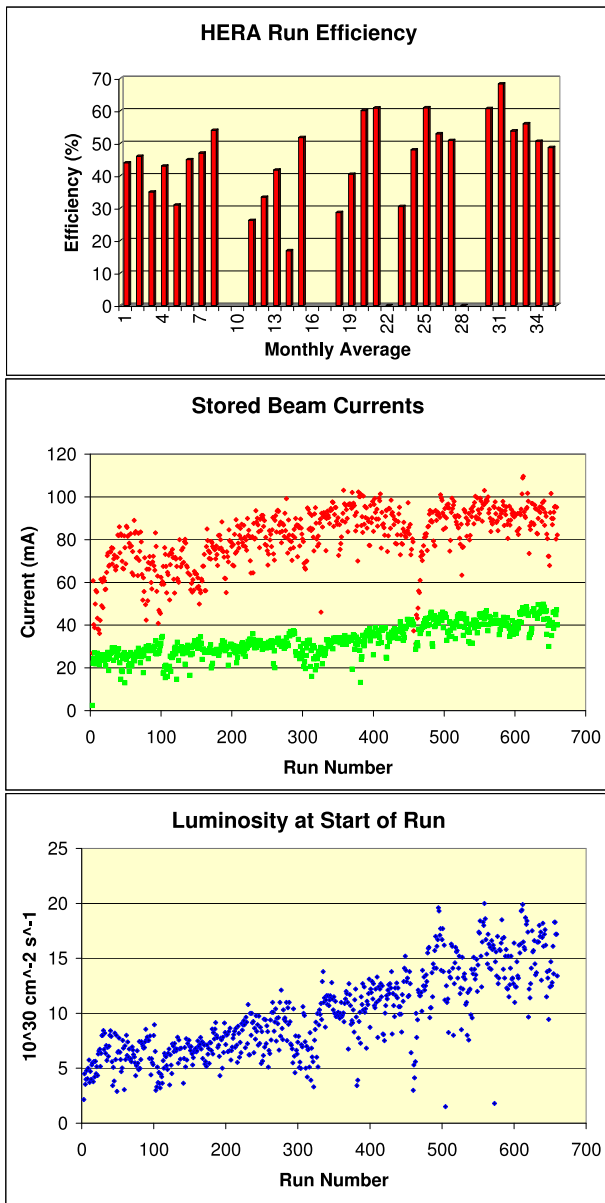

Figure 1: Improvements for HERA during the two years before June 2000. Top: run efficiency, Middle: maximum p (red, upper curve) and e (green, lower curve) currents, Bottom: maximum luminosity.

In order to focus the proton beam stronger in the experimental region, the electron beam has to be separated from the proton beam as early as possible [?, ?, ?, ?]. Whereas the first proton quadrupole is currently 26m after the IP this distance will be only 10m after the luminosity upgrade. Additionally the upgrade project includes 60m long spin rotators at both sides of the H1 and ZEUS detectors. The complete upgrade involves 448m of new vacuum pipes, 4 superconducting magnets for early separation of the e and p beams inside the detectors with a distance of only 2m from the IP, and 54 normal conducting magnets. The superconducting magnets have been built by BNL and the normal conducting magnets have been built by the Efremov Insti-

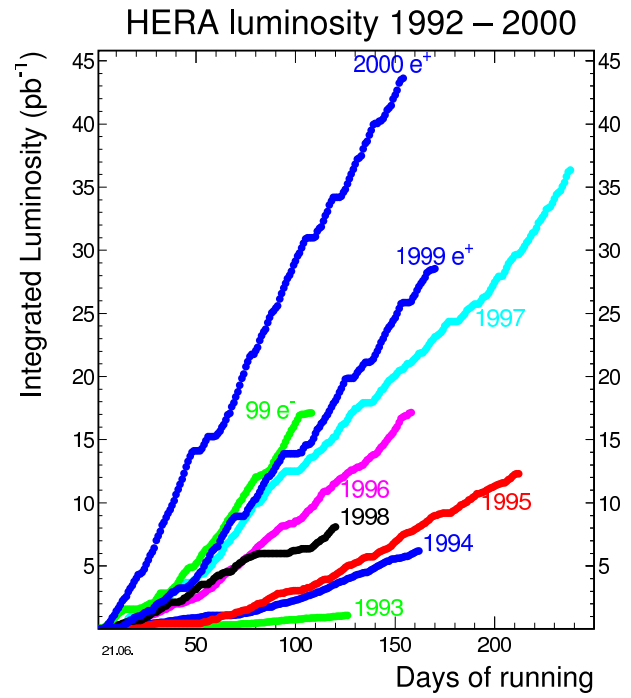

Figure 2: Integrated luminosity for each year of HERA running.

tute in St. Petersburg.

Whereas the magnet arrangement around the detectors is currently symmetric, it will no longer be symmetric after the upgrade as shown in figure 3. Due to the bends inside the detectors the synchrotron radiation can no longer be collimated before the experiment but has to be guided through the beam pipe. Starting at 11m after the IP, the radiation fan has its own beam pipe leading to a radiation absorber. Scattered electrons are collimated before the detector by a bend section and gas scattering close to the detector is minimized by as many NEG pumps as possible.

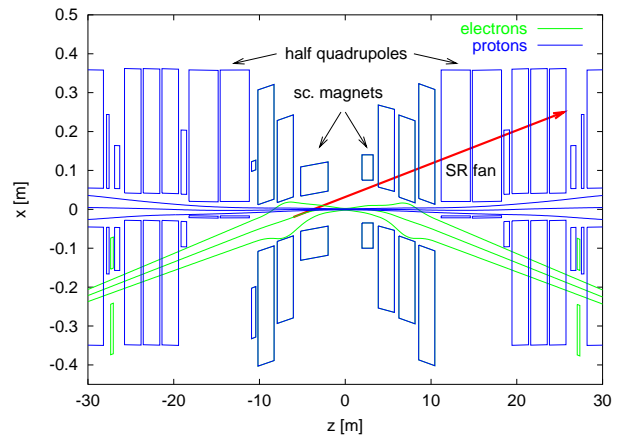

Figure 3: Layout of the interaction region after the luminosity upgrade.

Owing to the simultaneous presence of the proton beam, the electron beam, and the synchrotron radiation beam, some of the vacuum components are quite complicated. An example is shown in figure 4.

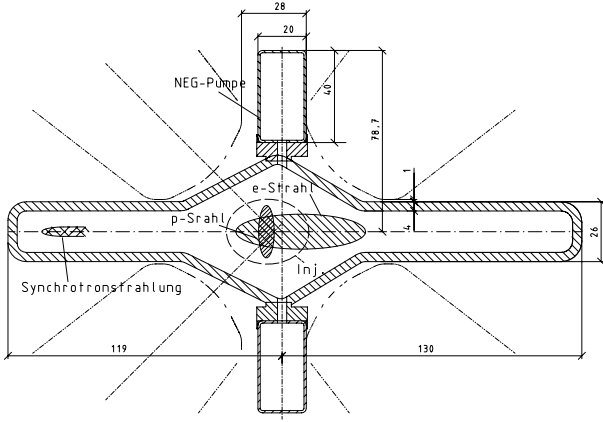

Figure 4: Custom designed vacuum chamber for the e beam, the p beam, and for the synchrotron radiation beam.

Also the detectors themselves will experience a major rebuild. Currently there are no magnets inside the detector except of its huge solenoid for particle identification and the corresponding compensation solenoid. After the luminosity upgrade there will be two combined function magnets inside each detector which are superconducting not to obtain strong fields but to allow for a small diameter which can be fitted inside the detectors. The compensation solenoid will be eliminated and coupling compensation will be done by skew quadrupole windings in these superconducting magnets. Together with the asymmetry of the interaction region, this will make spin matching more difficult and providing longitudinal electron polarization in the experiment will become quite challenging.

Important parameters of the luminosity upgrade project are shown in table 1. One of the critical points will be the exceptionally large vertical electron beam-beam tune shift $2\Delta\nu_y$ due to the 2 collider experiments. The luminosity \mathcal{L} is given in units of $\text{cm}^{-2}\text{s}^{-1}$ and the specific luminosity in units of $\text{cm}^{-2}\text{s}^{-1}\text{mA}^{-2}$. The polarization has not been accurately simulated yet and 45% is only a rough estimate.

3 POLARIZED PROTONS AT DESY

One long term future possibility for HERA is complementing HERA's polarized electron beam with polarized protons. Whereas the electron beam polarizes itself by emission of spin flip synchrotron radiation, the only feasible way of obtaining a high energy polarized proton beam is currently the acceleration of polarized protons after creation in a polarized H^- source [?]. As shown in figure ?? a proton beam at DESY is then accelerated by an RFQ to 750keV, then by the LINAC III to 50MeV, by the

Parameters	currently		after the Upgrade	
	e-ring	p-ring	e-ring	p-ring
$E(\text{GeV})$	27.5	920	27.5	920
$I(\text{mA})$	50	100	58	140
$N_{ppb}(10^{10})$	3.5	7.3	4.0	10.3
n_{tot}	189	180	189	180
n_{col}	174	174	174	174
$\beta_x^*(\text{m})$	0.90	7.0	0.63	2.45
$\beta_y^*(\text{m})$	0.60	0.5	0.26	0.18
$\epsilon_x(\text{nm})$	41	$\frac{5000}{\beta\gamma}$	20	$\frac{5000}{\beta\gamma}$
ϵ_y/ϵ_x	10%	1	17%	1
$\sigma_x/\sigma_y(\mu\text{m})$	192/50	189/50	112/30	112/30
$\sigma_z(\text{mm})$	11.2	191	10.3	191
$2\Delta\nu_x$	0.024	0.0026	0.068	0.0031
$2\Delta\nu_y$	0.061	0.0007	0.103	0.0009
Polarization	60%	0%	45%	0%
\mathcal{L}	$16.9 \cdot 10^{30}$		$75.7 \cdot 10^{30}$	
\mathcal{L}_s	$0.66 \cdot 10^{30}$		$1.82 \cdot 10^{30}$	

Table 1: Parameters of HERA before and after the luminosity upgrade.

DESY III synchrotron to a momentum of 7.5GeV/c, by the PETRA synchrotron to 40GeV/c and then by HERA-p to 920GeV/c. The 4 main challenges for the DESY polarized proton project are therefore: (1) Production of a 20mA pulsed H^- beam. (2) Polarimetry at various stages in the acceleration chain. (3) Acceleration through the complete accelerator chain with little loss of polarization. (4) Storage of a polarized beam at the top energy over many hours with little loss of polarization.

Today polarized H^- beams can be produced either by a polarized atomic beam source (ABS) or in an optically pumped polarized ion source (OPPIS) with the record of 60% polarization for 5mA. However, experts claim that currents of up to 20mA could be possible. For polarization monitoring and optimization, polarimeters will have to be installed at several crucial places in the accelerator chain. The polarimeters up to DESY III could be similar to the AGS polarimeters. For higher energies one has to wait and see how the novel techniques envisioned and developed for RHIC will work.

After a polarized proton beam has been accelerated to the high energy of 920GeV, the polarization has to be stable for several hours in order to be useful for the experiments H1 and ZEUS. Furthermore the polarization in all parts of the beam has to be nearly parallel during this storage time.

Resonance effects can depolarize the beam at beam energies where the number of spin rotations ν during one turn around the ring is coherent with the betatron tunes. First-order resonances can be avoided by fixing ν to an energy independent value of 0.5 by Siberian Snakes. However, ν can strongly vary over the beams phase space as shown in figure ?? (blue, bottom curve) and higher-order depolarizing resonance effects can occur at specific phase space amplitudes in the beam. This is illustrated by the maxi-

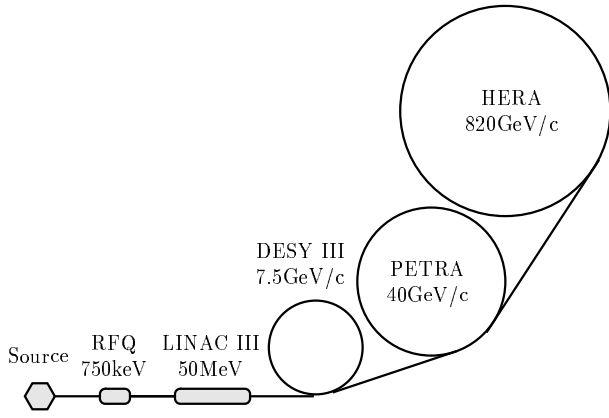

Figure 5: The accelerator chain at DESY for high energy collisions in HERA.

imum storable polarization P_{lim} (red, top curve) which is strongly diminished in phase space regions where higher order resonance effect with one of the orbital tunes occur. After finding a stable combination of 4 Siberian Snakes, simulation of the acceleration process show that between 75% and 85% of the polarization which was injected into HERA at 40GeV could remain at 800GeV if no misalignments would be present in the ring [?]. In addition to the 4 Siberian Snakes, 8 flattening snakes to compensate HERA's non-flat regions and 4 spin rotators would be required.

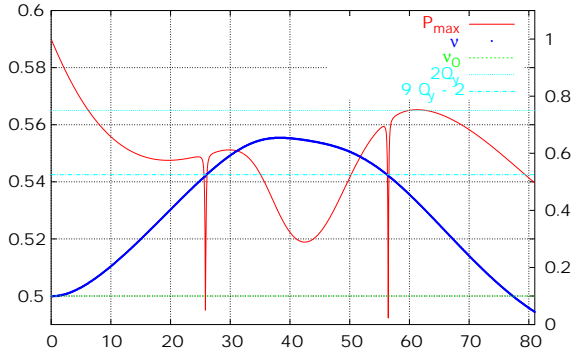

Figure 6: Higher order resonances between the phase space dependent spin tune ν (blue, bottom curve) and the orbit tunes are reflected by a reduced average polarization P_{lim} (red, top curve).

4 POLARIZED DEUTERONS

For deuterons the magnetic anomaly G and therefore spin perturbations in a transverse magnetic field are smaller by a factor of 12.5 than for protons. Furthermore the energy of deuterons in HERA would be only half of that for protons. Therefore the perturbations of spins due to transverse magnetic fields are smaller by a factor of 25 for deuterons. Additionally only 25 times less resonances have to be crossed

when accelerating a deuteron beam and the energies where resonances occur are 12.5 times further apart so that higher order effects due to an overlap are strongly reduced. This reduction of the significance of depolarizing resonances for deuterons can clearly be seen in figure ?? where their strength is shown for protons (top) and for deuterons (bottom).

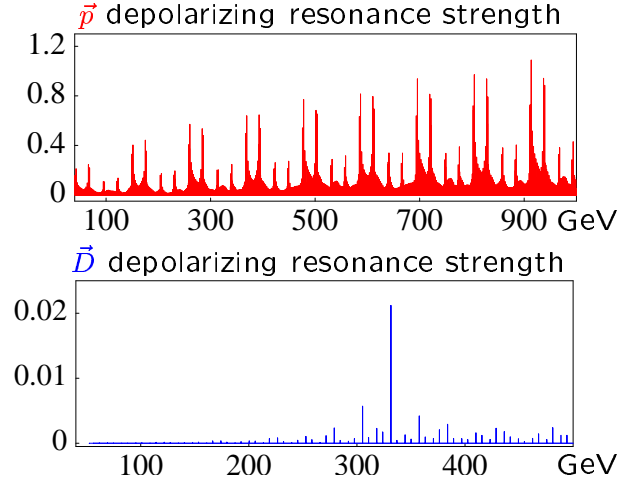

Figure 7: Strength of depolarizing resonances for protons (top) and deuterons (bottom).

Nevertheless, rotating transverse deuteron spins into the longitudinal direction has been found to be very difficult in the past. Novel ideas for rotating a transverse polarization into the longitudinal by means of magnetic rf dipole fields [?] might change this situation significantly.

5 IONS IN HERA

To accelerate an arbitrary light or heavy ion beam in HERA, a new LINAC would be required. For deuterons or some lighter ions however the current LINAC could be used in the $2\beta\lambda$ mode which would lead to a beam which would leave the LINAC with half the speed of the proton beam. Currently the frequency sweep of the rf cavities in DESY III is about 3; it then would have to be around 6, which is intolerable. Therefore either a changed rf system in DESY III would be required or one would need to inject at a harmonic number of e.g. 22 and then rebunch to the current harmonic number 11 after acceleration to higher particle velocities. The following accelerators PETRA and HERA would also require a larger frequency sweep, but these should be achievable by rebuilding the tuners of the cavities.

With the current optics in PETRA and in HERA γ_t would have to be crossed during the acceleration; a complication which is currently not encountered in any of the DESY accelerators. First investigations show however that a change of optics could lead to a sufficiently reduced γ_t so that it will not have to be crossed.

The largest remaining problem with ions in HERA is intra beams scattering (IBS). The high energy physics com-

	Deuteron	$^{16}O^{8+}$	$^{208}Pb^{82+}$
ϵ_N	$2.5\mu\text{m}$	$2.5\mu\text{m}$	$2.0\mu\text{m}$
N_{ppb}	$5.0 \cdot 10^{10}$	$6.0 \cdot 10^9$	$4.8 \cdot 10^8$
\mathcal{L}	$3.5 \cdot 10^{31}$	$4.4 \cdot 10^{30}$	$3.4 \cdot 10^{29}$
$\sum_{xyz} \tau_{IBS}$	140min	20min	2.5min

Table 2: Maximum luminosity \mathcal{L} and intra beam scattering times τ_{IBS} for different ions in HERA.

munity requests that the luminosity for electron nucleon scattering $A \cdot \mathcal{L}_A$ for ions with A nucleons will not be smaller than the current luminosity. Table ?? shows the number of particles per bunch N_{ppb} needed to obtain this luminosity $\mathcal{L}_A = \mathcal{L}_p/A$ for three different ions. The IBS times become unacceptably small for heavy ions in HERA. This shows that the requested luminosities can only be obtained by balancing the IBS by a cooling mechanism.

6 E-COOLING AT PETRA AND HERA

The possibility of using electron cooling to counterbalance IBS of ion beams has been investigated. However, electron cooling would not only be essential for collisions of heavy ions with electron but also the e/p luminosity could be increased by a factor of 2 and a reduction of the proton emittance would reduce depolarizing effects which simplifies the acceleration of polarized protons.

A simplified expression of cooling times in equation ?? shows that cooling at high energy is extremely slow. However, if one had a small emittance at high energy to start with, the IBS could possibly be balanced. This gave rise to the idea of precooling in PETRA at $\gamma = 19$ by a cooler sketched in figure ?? and to subsequently keep the emittance small with an electron cooling in HERA sketched in figure ?? [?, ?, ?].

$$\tau_{long} \propto \frac{A}{Z} \gamma^4 \sqrt{\epsilon_p^2} \frac{1}{Z}, \quad \tau_{trans} \propto \frac{A}{Z} \gamma^3 \sqrt{\epsilon_p^3} \frac{1}{Z}. \quad (2)$$

Both coolers would have a bunched electron beam to use the complete electron current for cooling the bunched hadron beams. For doubling the luminosity for e/p collisions for example, simulations have shown the feasibility of cooling emittances of 5 (measured in $\pi\text{mm mrad}$) in PETRA to $\epsilon_x = 3.3$, $\epsilon_y = 0.8$ and to subsequently preserve emittances of $\epsilon_x = 3.8$, $\epsilon_y = 0.9$ in HERA.

While HERA is currently and for many years to come the main accelerator at DESY for obtaining physics data, the main future accelerator for DESY is the TESLA linear collider. Here it has to suffice to state that in this context the following two ideas have been discussed: (1) using HERA as a pulse stretcher for electron pulses from TESLA for an ELSE at DESY nuclear physics facility and (2) using HERA for hadron collisions with the TESLA electron beam.

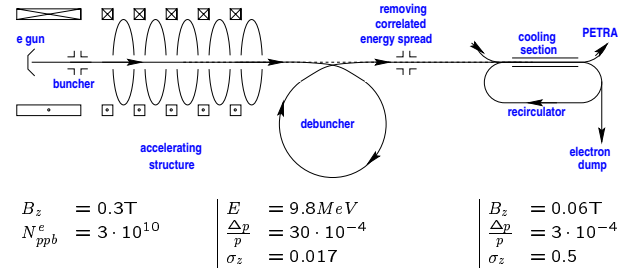

Figure 8: Layout of the proposed electron cooler for PETRA.

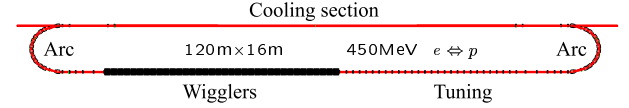

Figure 9: Layout for the proposed electron cooler ring for HERA.

7 REFERENCES

- [1] Editor: U. Schneekloth, "The HERA Luminosity Upgrade", Report DESY-HERA-98-05 (1998)
- [2] M. Seidel, "The Upgraded Interaction Regions of HERA", Report DESY-HERA-00-01 (2000)
- [3] M. Seidel, "Layout of the Upgraded HERA Interaction Regions", Proceedings of EPAC00, Vienna (2000)
- [4] G. H. Hoffstaetter, "Electron Dynamics after the HERA Luminosity upgrade", Proceedings of EPAC00, Vienna (2000)
- [5] The SPIN Collaboration and the DESY polarization team, "Acceleration of Polarized Protons to 820 GeV at HERA", University of Michigan Report Report UM-HE-96-20 (1996)
- [6] The SPIN Collaboration and the DESY polarization team, "Acceleration of Polarized Protons to 920 GeV at HERA", University of Michigan Report UM-HE-99-05 (1999)
- [7] G. H. Hoffstaetter, "Aspects of the Invariant Spin Field for Polarized Protons in HERA", Habilitation thesis Darmstadt University of Technology (2000)
- [8] M. Vogt, "Limits for the Achievable Proton Polarization at HERA", Doctoral thesis University of Hamburg (2000)
- [9] V. Anferov and Y. Derbenev, "A Novel Method of Flipping Proton Polarization", PRST-AB 12, 1345 (2000)
- [10] M. Gentner, R. Brinkmann, Y. Derbenev, D. Husmann, and C. Steier, "On the possibilities of electron cooling for HERA", Nucl. Instr. Meth. A 424, 277-295 (1999)
- [11] K. Balewski, R. Brinkmann, Y. Derbenev, K. Floettmann, P. Wesolowski, M. Gentner, D. Husmann, and C. Steier "Studies of electron cooling at DESY", Nucl. Instr. Meth. A 441, 274-280 (2000)
- [12] P. Wesolowski, K. Balewski, R. Brinkmann, Y. Derbenev, and K. Floettmann, "An injector study for electron cooling at PETRA using a bunched beam", Nucl. Instr. Meth. A 441 281-285 (2000)